

data sheet: G2G50

Kroepin GmbH
Gartenstraße 50
D-36381 Schlüchtern

Tel.: 06661 86 0
Fax: 06661 86 39
Mail: sales@kroepin.com
Web: www.kroepin.com

Kroepin
Längenmesstechnik

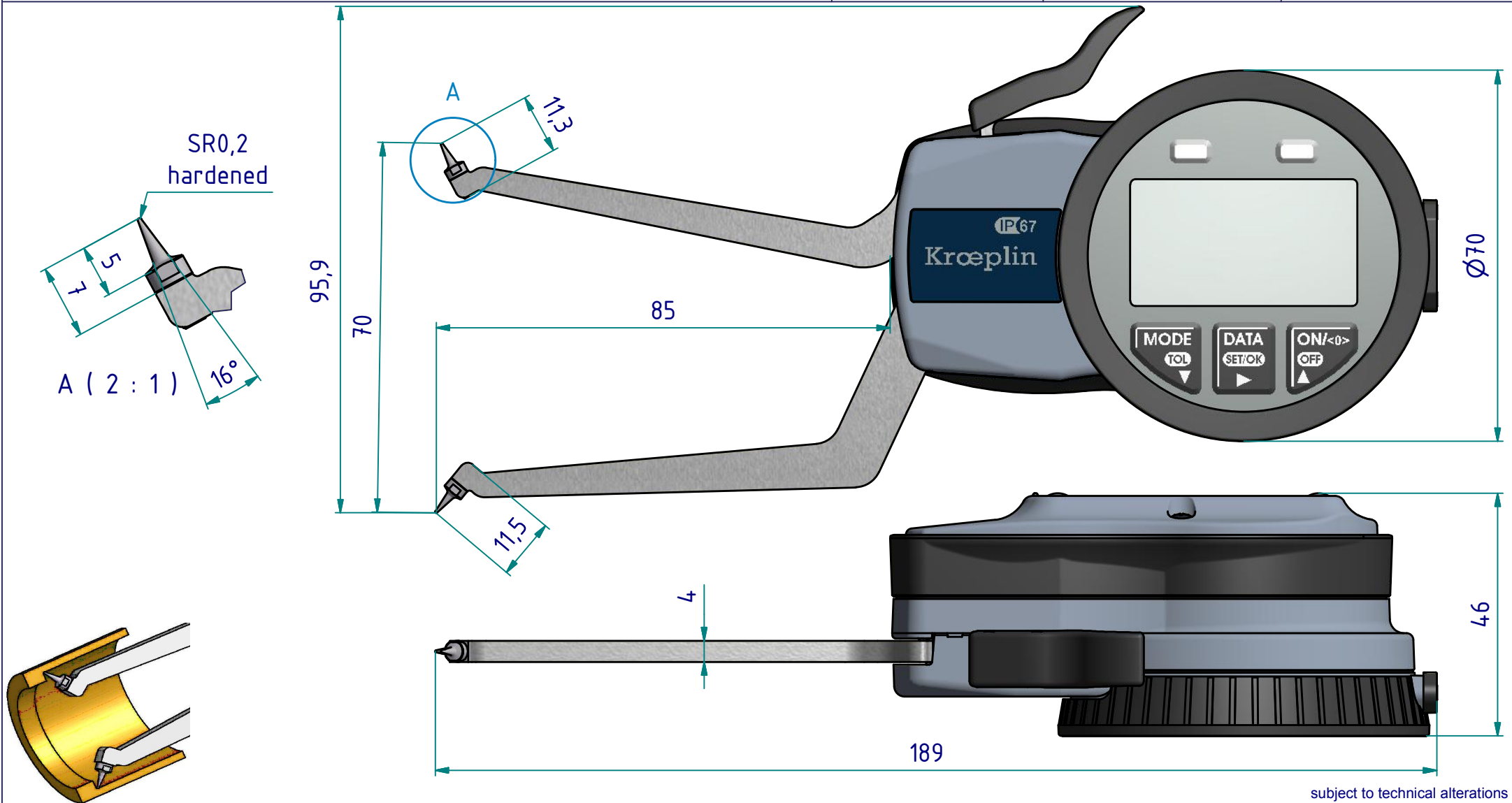

subject to technical alterations

type: G
range: 50 - 70 mm
range of indication: 49,5 - 70,5 mm
digital step: 0,01 mm
scale interval: -
measuring force: 1,1 - 1,6 N
weight: 265 g

acceptable deviations
 VDI/VDE/DGQ 2618 Bl. 12.1/13.1)
max. permissible errors "G": 0,03 mm
repeatability "r": 0,01 mm
reference temperature: 20° C
operation temperature: 10° C - 30° C
storage temperature: -10° C - 50° C

scale: 1:1
drawing-nr.: DAB-G2G50_KR_e
date of issue: 07.01.09
name: M. Balzer
revision status:
revision date:

interface as accessories available:

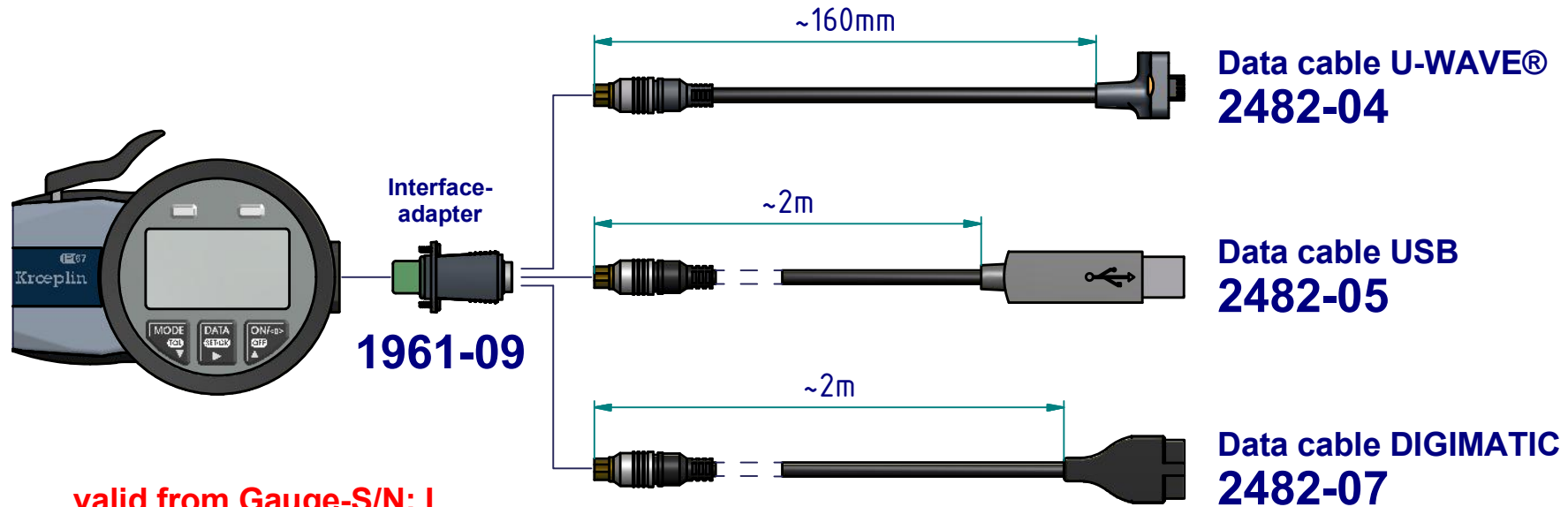

valid from Gauge-S/N: I
Always specify serial number
when ordering Interfaces or accessories!

subject to technical alterations

drawing-nr.:	DAB-G2G50_KR_e
date of issue:	07.01.09
name:	M. Balzer
revision status:	2043
revision date:	24.02.12