

# data sheet: H2G80

Kroepelin GmbH  
Gartenstraße 50  
D-36381 Schlüchtern

Tel.: 06661 86 0  
Fax: 06661 86 39  
Mail: sales@kroepelin.com  
Web: www.kroepelin.com

**Kroepelin**  
Längenmesstechnik

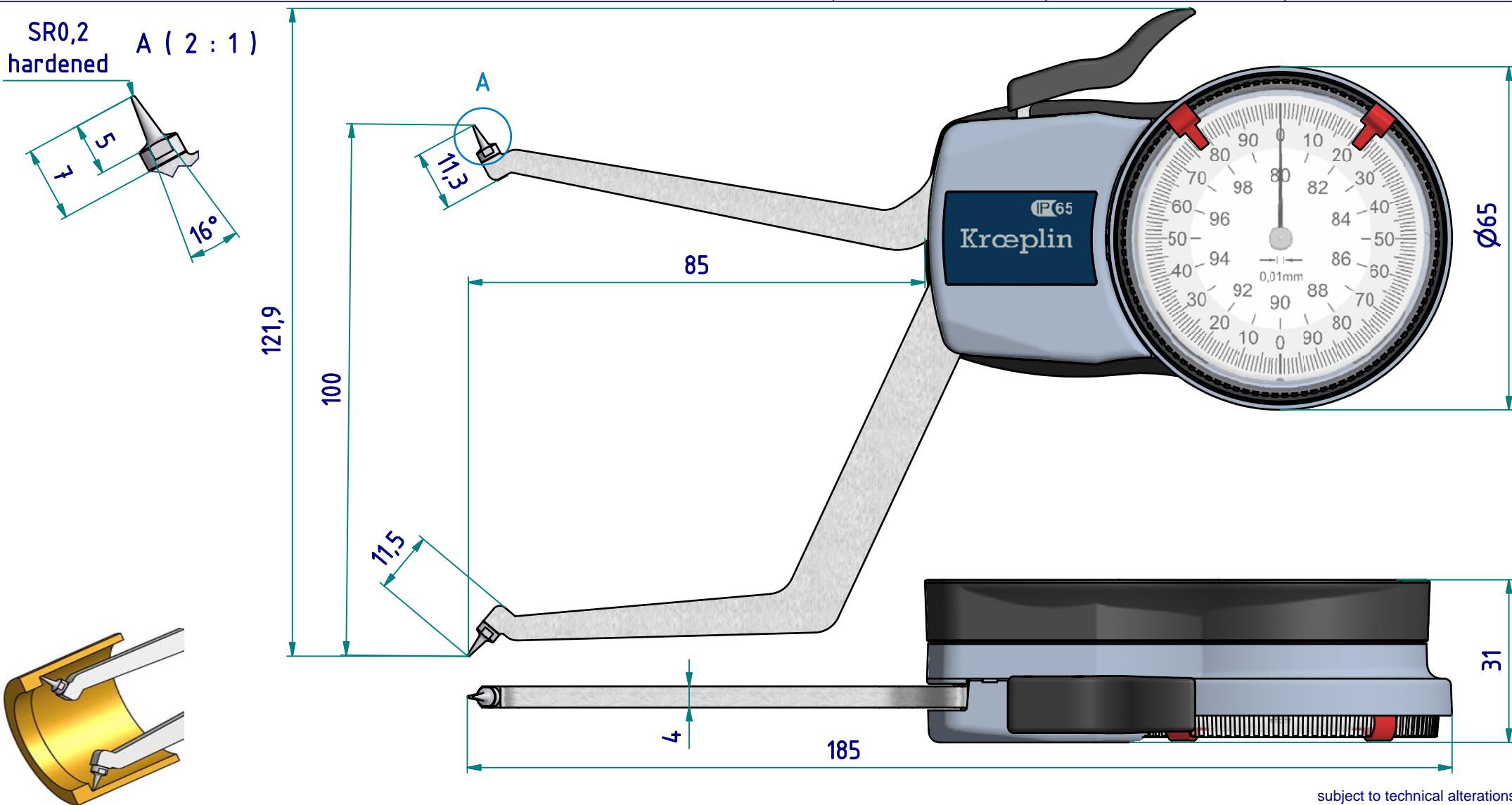

subject to technical alterations

type: H  
range: 80 - 100 mm  
range of indication: 79,5 - 100,5 mm  
digital step: -  
scale interval: 0,01 mm  
measuring force: 1,1 - 1,6 N  
weight: 200 g

acceptable deviations  
VDI/VDE/DGQ 2618 Bl. 12.1/13.1)  
max. permissible  
errors "G": 0,03 mm  
repeatability "r": 0,01 mm  
reference temperature: 20° C  
operation temperature: 10° C - 30° C  
storage temperature: -10° C - 50° C

scale: 1:1  
drawing-nr.: DAB-H2G80\_KR\_e  
date of issue: 08.01.09  
name: T.Koenig  
revision status:  
revision date: